

Silicon Diode

1N5415

50V / 3A

DATASHEET

OEM – Unitrode

Source: Unitrode Databook 1989-1990

RECTIFIERS

Military Approved, Fast Recovery, 3 Amp

1N5415-1N5420
JAN, JANTX & JANTXV

FEATURES

- Qualified to MIL-S-19500/411
- PIV: to 600V
- Controlled Avalanche

DESCRIPTION

This series of devices as designed to meet the need for high speed, power rectifiers in military high-rel power supplies.

ABSOLUTE MAXIMUM RATINGS

Peak Inverse Voltage	Type
50V	JAN, JANTX, JANTXV 1N5415
100V	JAN, JANTX, JANTXV 1N5416
200V	JAN, JANTX, JANTXV 1N5417
400V	JAN, JANTX, JANTXV 1N5418
500V	JAN, JANTX, JANTXV 1N5419
600V	JAN, JANTX, JANTXV 1N5420

Maximum Average D.C. Output Current
 @ $T_A = 55^\circ\text{C}$ 3.0A
 @ $T_A = 100^\circ\text{C}$ 2.0A
 Non-Repetitive Sinusoidal
 Surge Current (8.3ms) 80A
 Operating Temperature Range -65°C to $+175^\circ\text{C}$
 Storage Temperature Range -65°C to $+200^\circ\text{C}$
 Thermal Resistance θ_{JL} @ $L = \frac{3}{8}"$ $20^\circ\text{C}/\text{W}$
 See Lead Temperature Derating Curve

MECHANICAL SPECIFICATIONS

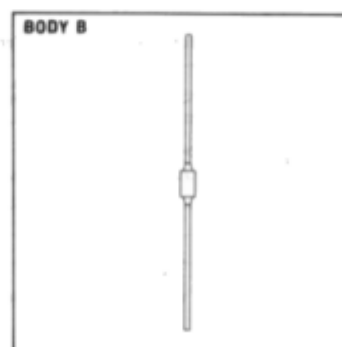
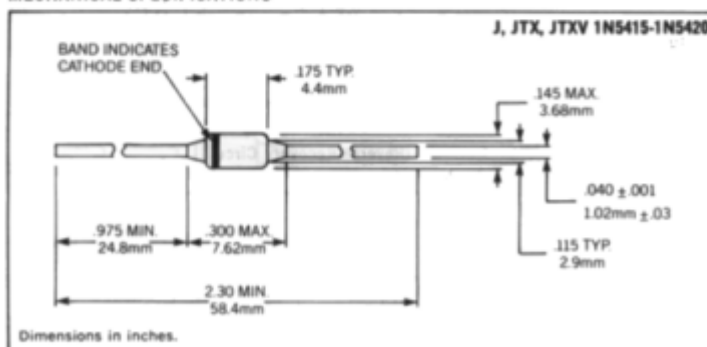

THESE DEVICES ALSO AVAILABLE IN SURFACE MOUNT PACKAGE. SEE SECTION 11.

JAN, JANTX, JANTXV 1N5415 - 1N5420

ELECTRICAL SPECIFICATIONS (at 25°C unless noted)

Type	PIV	Minimum Reverse Breakdown Voltage @ 50µA	Forward Voltage		Maximum Reverse Current		Maximum Reverse Recovery Time*
			Min.	Max.	25°C	100°C	
J, JTX, JTXV 1N5415	50V	55V	0.6V @ 9Adc tp = 300µs	1.5V(pk)	1.0µA	20µA	150
J, JTX, JTXV 1N5416	100V	110V					150
J, JTX, JTXV 1N5417	200V	220V					150
J, JTX, JTXV 1N5418	400V	440V					150
J, JTX, JTXV 1N5419	500V	550V					250
J, JTX, JTXV 1N5420	600V	660V					400

*Measured in circuit $I_F = 0.5 \text{ A}$, $I_R = 1 \text{ A}$, $t_{REC} = 0.25 \text{ A}$.

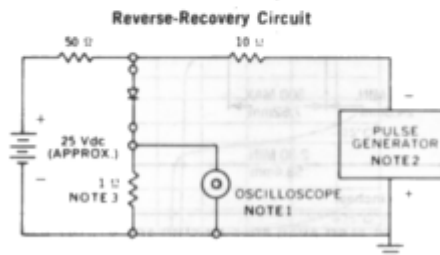
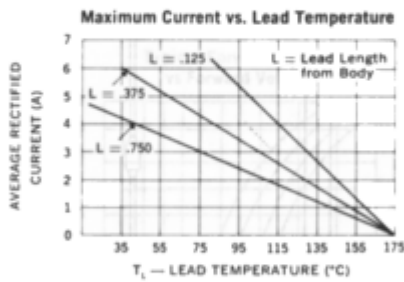
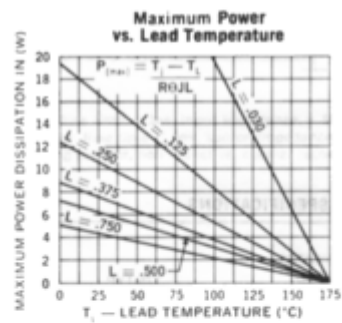
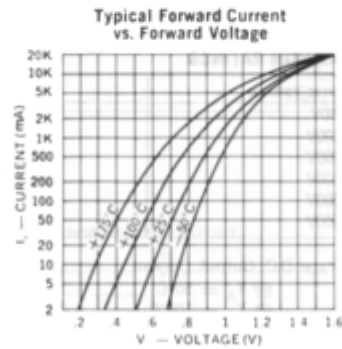
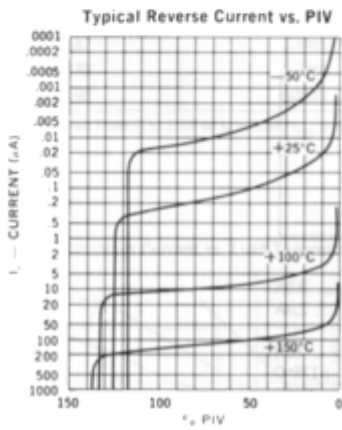

- NOTES:**
- Oscilloscope: Rise time $\leq 3\text{ns}$; input impedance $\geq 50\Omega$.
 - Pulse Generator: Rise time $\leq 8\text{ns}$; source impedance 10Ω .
 - Current viewing resistor, non-inductive, coaxial recommended.