

Silicon Diode

BYD143

400V/1A

DATASHEET

OEM – Philips

Source: Philips Databook 1999

Ultra fast low-loss rectifiers

BYD143

FEATURES

- Glass passivated
- High maximum operating temperature
- Low leakage current
- Excellent stability
- Available in ammo-pack.

DESCRIPTION

Cavity free cylindrical glass SOD81 package through Implotec™(1) technology. This package is

hermetically sealed and fatigue free as coefficients of expansion of all used parts are matched.

(1) Implotec is a trademark of Philips.

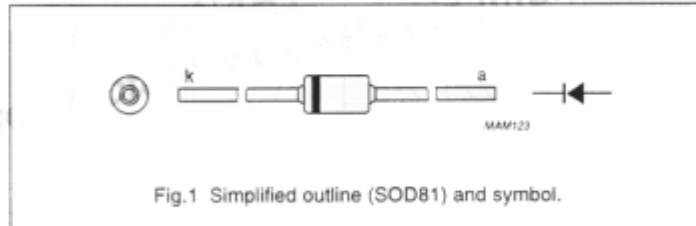

Fig.1 Simplified outline (SOD81) and symbol.

LIMITING VALUES

In accordance with the Absolute Maximum Rating System (IEC 134).

SYMBOL	PARAMETER	CONDITIONS	MIN.	MAX.	UNIT
V_{RRM}	repetitive peak reverse voltage		–	400	V
V_R	continuous reverse voltage		–	400	V
$I_{F(AV)}$	average forward current	$T_{ip} = 105\text{ °C}$; lead length = 10 mm; averaged over any 20 ms period; see Figs 5 and 6	–	1	A
I_{FSM}	non-repetitive peak forward current	$t = 10\text{ ms}$ half sinewave; $V_R = V_{RRMmax}$	–	25	A
T_{stg}	storage temperature		–65	+175	°C
T_j	junction temperature		–65	+175	°C

ELECTRICAL CHARACTERISTICS

$T_j = 25\text{ °C}$ unless otherwise specified.

SYMBOL	PARAMETER	CONDITIONS	MAX.	UNIT
V_F	forward voltage	$I_F = 1\text{ A}$; see Fig.2 $T_j = 150\text{ °C}$	0.95	V
		$I_F = 1\text{ A}$; see Fig.2	1.15	V
I_R	reverse current	$V_R = V_{RRMmax}$; see Fig.3	5	μA
		$V_R = V_{RRMmax}$; $T_j = 150\text{ °C}$; see Fig.3	150	μA
t_{rr}	reverse recovery time	when switched from $I_F = 0.5\text{ A}$ to $I_R = 1\text{ A}$; measured at $I_R = 0.25\text{ A}$	50	ns

Ultra fast low-loss rectifiers

BYD143

THERMAL CHARACTERISTICS

SYMBOL	PARAMETER	CONDITIONS	VALUE	UNIT
$R_{th\ j-tp}$	thermal resistance from junction to tie-point	lead length = 10 mm	60	K/W
$R_{th\ j-a}$	thermal resistance from junction to ambient	note 1	120	K/W

Note

1. Device mounted on epoxy-glass printed-circuit board, 1.5 mm thick; thickness of copper $\geq 40\ \mu\text{m}$, see Fig.7.
For more information please refer to the "General part of the associated handbook".

Ultra fast low-loss rectifiers

BYD143

GRAPHICAL DATA

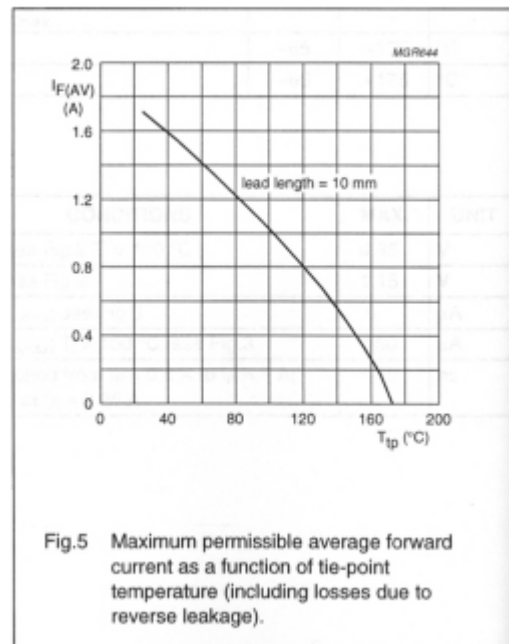
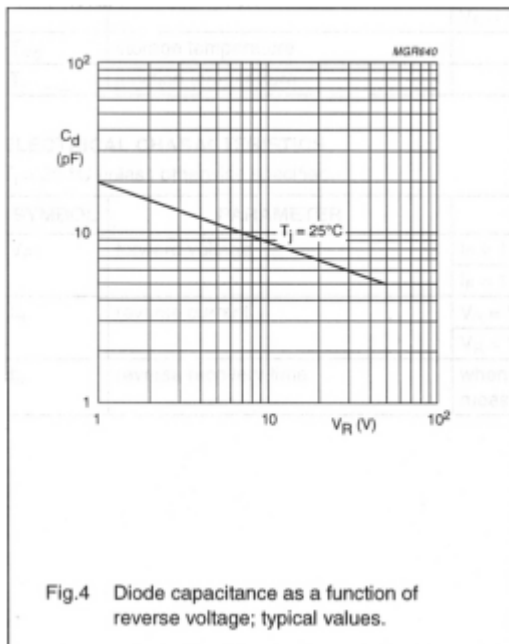
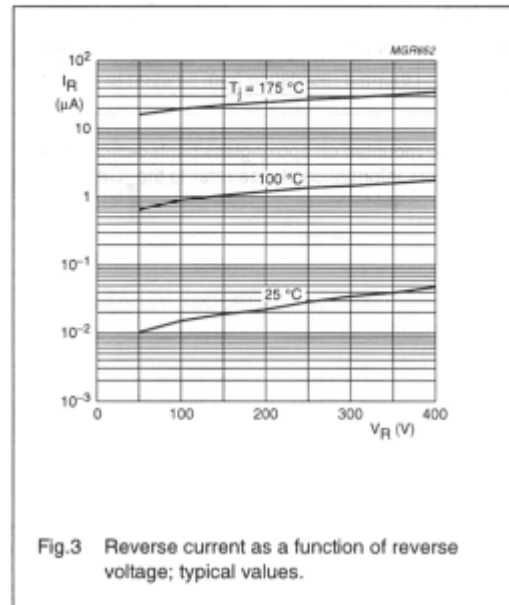
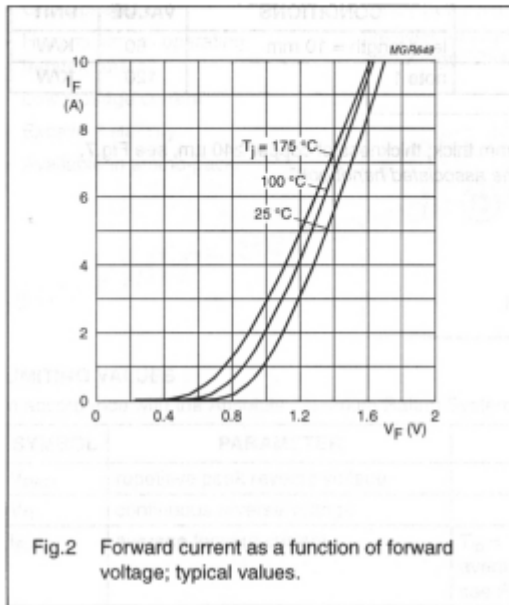

Ultra fast low-loss rectifiers

BYD143

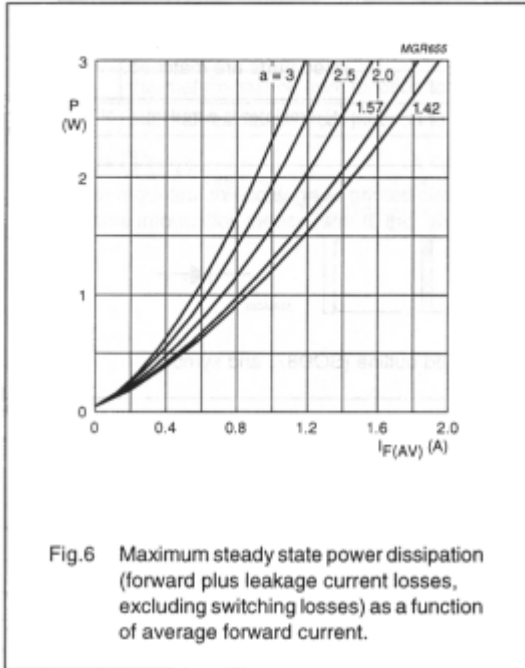
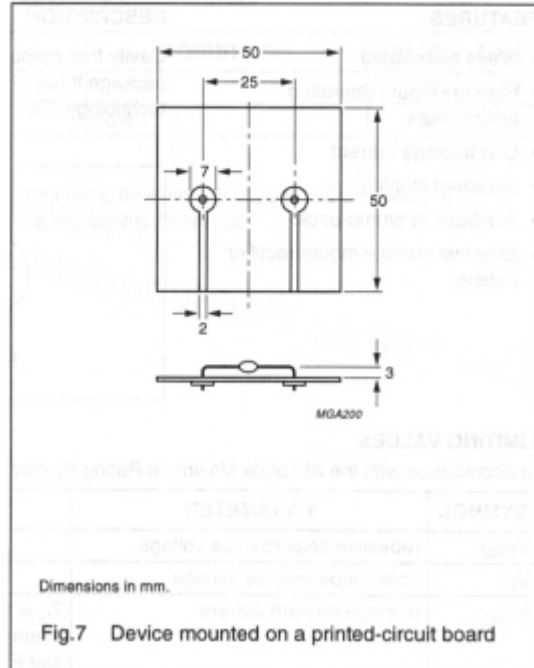

Fig.6 Maximum steady state power dissipation (forward plus leakage current losses, excluding switching losses) as a function of average forward current.



Dimensions in mm.

Fig.7 Device mounted on a printed-circuit board