

Silicon Diode

BY8104

4kV/20mA

DATASHEET

OEM – Philips

Source: Philips Databook 1999

Very fast high-voltage soft-recovery controlled avalanche rectifiers

BY8100 series

FEATURES

- Glass passivated
- High maximum operating temperature
- Low leakage current
- Excellent stability
- Guaranteed avalanche energy absorption capability
- Soft-recovery switching characteristics
- Compact construction.

APPLICATIONS

- For colour television and monitors up to 128 kHz
- High-voltage applications for:
 - Multipliers
 - Layer-wound diode-split-transformers where controlled avalanche is required.

DESCRIPTION

Rugged glass package, using a high temperature alloyed construction. This package is hermetically sealed and fatigue free as coefficients of

expansion of all used parts are matched.

The package is designed to be used in an insulating medium such as resin, oil or SF6 gas.

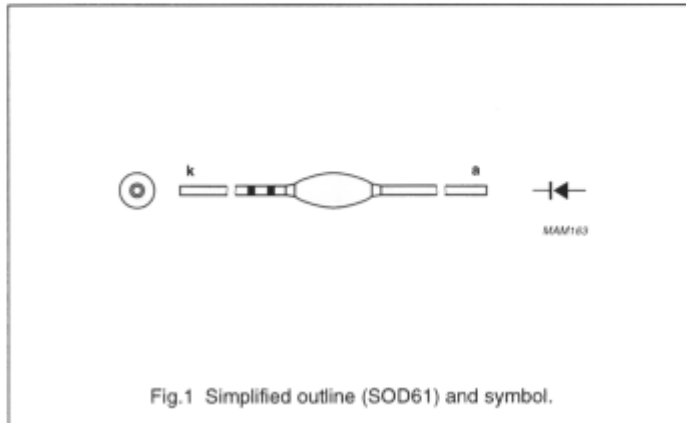

MARKING

Cathode band colour codes

TYPE NUMBER	PACKAGE CODE	INNER BAND	OUTER BAND
BY8104	SOD61AC	orange	black
BY8106	SOD61AD	orange	green
BY8108	SOD61AE	orange	red
BY8110	SOD61AF	orange	violet
BY8112	SOD61AH	orange	orange
BY8114	SOD61AI	orange	lilac
BY8116	SOD61AJ	orange	grey

Note: The inner and outer band are probably inverted according to the global databook reference table Databook SC11, Philips Power Diodes 1998 Dec 07, Page 64 in reference to other diode types from the same family

Power Diodes

Marking codes

TYPE NUMBER TO MARKING CODE

TYPE NUMBER	MARKING CODE	PACKAGE	TYPE NUMBER	MARKING CODE	PACKAGE
1N4001G	1N4001 PH	SOD57	BY558	BY558 PH	SOD115
1N4002G	1N4002 PH	SOD57	BY578	BY578 PH	SOD115
1N4003G	1N4003 PH	SOD57	BY584	orange	SOD61A
1N4004G	1N4004 PH	SOD57	BY614	black	SOD61H2
1N4005G	1N4005 PH	SOD57	BY8004	violet+black	SOD61AC
1N4006G	1N4006 PH	SOD57	BY8006	violet+green	SOD61AD
1N4007G	1N4007 PH	SOD57	BY8008	violet+red	SOD61AE
1N4001ID	1N4001	SOD81	BY8010	violet+violet	SOD61AF
1N4002ID	1N4002	SOD81	BY8012	violet+orange	SOD61AH
1N4003ID	1N4003	SOD81	BY8014	violet+lilac	SOD61AI
1N4004ID	1N4004	SOD81	BY8016	violet+grey	SOD61AJ
1N4005ID	1N4005	SOD81	BY8104	orange+black	SOD61AC
1N4006ID	1N4006	SOD81	BY8106	orange+green	SOD61AD
1N4007ID	1N4007	SOD81	BY8108	orange+red	SOD61AE
1N5059	1N5059 PH	SOD57	BY8110	orange+violet	SOD61AF
1N5060	1N5060 PH	SOD57	BY8112	orange+orange	SOD61AH
1N5061	1N5061 PH	SOD57	BY8114	orange+lilac	SOD61AI
1N5062	1N5062 PH	SOD57	BY8116	orange+grey	SOD61AJ
1N5817	1N5817	SOD81	BY8206	green+green	SOD118A
1N5818	1N5818	SOD81	BY8208	green+red	SOD118A
1N5819	1N5819	SOD81	BY8210	green+violet	SOD118B
BAQ800	BAQ800-PH	SOD81	BY8212	green+orange	SOD118B
BAQ806	BAQ 806 PH	SOD106	BY8404	black+black	SOD61AB
BAT120A	AT120A	SOT223	BY8406	black+green	SOD61AC
BAT120C	AT120C	SOT223	BY8408	black+red	SOD61AD
BAT120S	AT120S	SOT223	BY8410	black+violet	SOD61AE
BAT140A	AT140A	SOT223	BY8412	black+orange	SOD61AF
BAT140C	AT140C	SOT223	BY8414	black+lilac	SOD61AG
BAT140S	AT140S	SOT223	BY8416	black+grey	SOD61AH
BAT160A	AT160A	SOT223	BY8418	black+brown	SOD61AI
BAT140C	AT160C	SOT223	BY8420	black+blue	SOD61AJ
BAT140S	AT160S	SOT223	BY8424	black	SOD61AK
BY228	BY228 PH	SOD64	BY9206	light blue+green	SOD118A
BY278	BY278 PH	SOD64	BY9208	light blue+red	SOD118A
BY328	BY328 PH	SOD64	BY9210	light blue+violet	SOD118B
BY428	BY428 PH	SOD64	BY9212	light blue+orange	SOD118B
BY448	BY448 PH	SOD57	BY9304	white	SOD118A
BY505	black	SOD61A	BY9306	white+green	SOD118A
BY527	BY527 PH	SOD57	BY9308	white+red	SOD118A

Very fast high-voltage soft-recovery
controlled avalanche rectifiers

BY8100 series

LIMITING VALUES

In accordance with the Absolute Maximum Rating System (IEC 134).

SYMBOL	PARAMETER	CONDITIONS	MIN.	MAX.	UNIT
V _{RRM}	repetitive peak reverse voltage				
	BY8104		–	5	kV
	BY8106		–	8	kV
	BY8108		–	10	kV
	BY8110		–	12	kV
	BY8112		–	14	kV
	BY8114		–	17	kV
V _{RW}	working reverse voltage				
	BY8104		–	4	kV
	BY8106		–	6	kV
	BY8108		–	8	kV
	BY8110		–	10	kV
	BY8112		–	12	kV
	BY8114		–	14	kV
I _{F(AV)}	average forward current	averaged over any 20 ms period; see Figs 2 to 8			
	BY8104		–	20	mA
	BY8106		–	10	mA
	BY8108		–	5	mA
	BY8110		–	5	mA
	BY8112		–	5	mA
	BY8114		–	5	mA
I _{FRM}	repetitive peak forward current	note 1	–	500	mA
P _{RSM}	non-repetitive peak reverse power dissipation	t = 20 μs half sinewave; T _j = T _{jmax} prior to surge			
	BY8104		–	1.7	kW
	BY8106		–	2.5	kW
	BY8108		–	3.0	kW
	BY8110		–	3.8	kW
	BY8112		–	5.0	kW
	BY8114		–	5.5	kW
T _{stg}	storage temperature		–65	+120	°C
T _j	junction temperature		–65	+120	°C

Note

1. Withstands peak currents during flash-over in a picture tube.

 Very fast high-voltage soft-recovery
 controlled avalanche rectifiers

BY8100 series

ELECTRICAL CHARACTERISTICS $T_J = 25\text{ }^\circ\text{C}$; unless otherwise specified.

SYMBOL	PARAMETER	CONDITIONS	MIN.	TYP.	MAX.	UNIT
V_F	forward voltage	$I_F = 100\text{ mA}$; $T_J = T_{J\text{max}}$; see Figs 9 to 15	-	-	26	V
	BY8104					
	BY8106					
	BY8108					
	BY8110					
	BY8112					
	BY8114					
BY8116						
I_R	reverse current	$V_R = V_{RW\text{max}}$; $T_J = 120\text{ }^\circ\text{C}$	-	-	3	μA
Q_r	recovery charge	when switched from $I_F = 100\text{ mA}$ to $V_R \geq 100\text{ V}$ and $dI_F/dt = -200\text{ mA}/\mu\text{s}$; see Fig.16	-	-	0.4	nC
t_f	fall time	when switched from $I_F = 100\text{ mA}$ to $V_R \geq 100\text{ V}$ and $dI_F/dt = -200\text{ mA}/\mu\text{s}$; see Fig.16	40	-	-	ns
t_{rr}	reverse recovery time	when switched from $I_F = 2\text{ mA}$ to $I_R = 4\text{ mA}$; measured at $I_R = 1\text{ mA}$; see Fig.17	-	-	60	ns
C_d	diode capacitance	$V_R = 0\text{ V}$; $f = 1\text{ MHz}$	-	0.90	-	pF
	BY8104					
	BY8106					
	BY8108					
	BY8110					
	BY8112					
	BY8114					
BY8116						

Very fast high-voltage soft-recovery
controlled avalanche rectifiers

BY8100 series

GRAPHICAL DATA

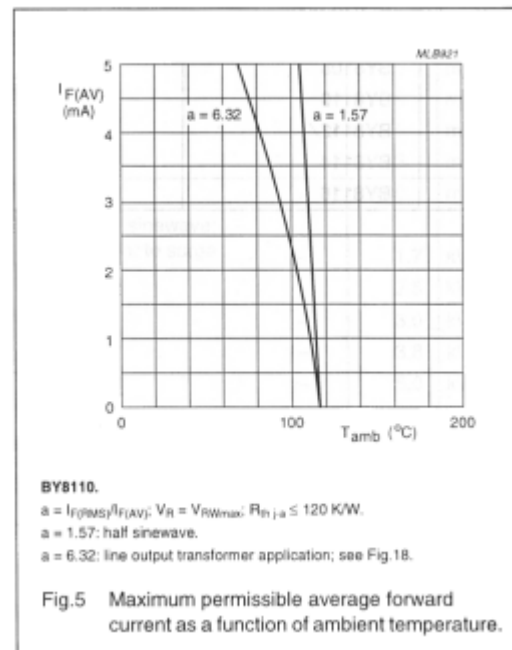
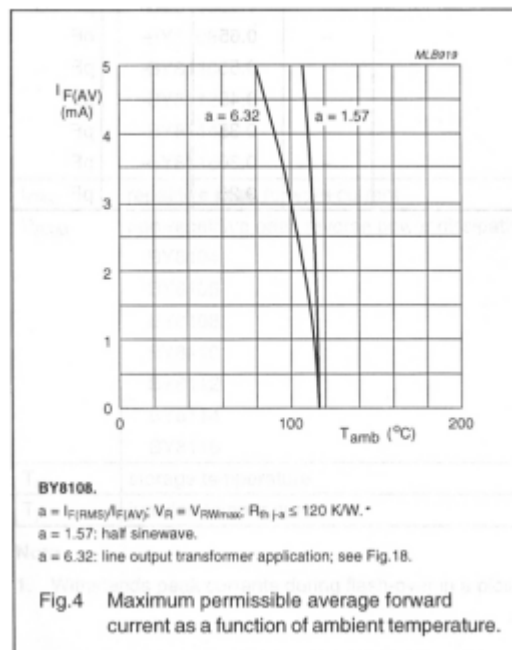
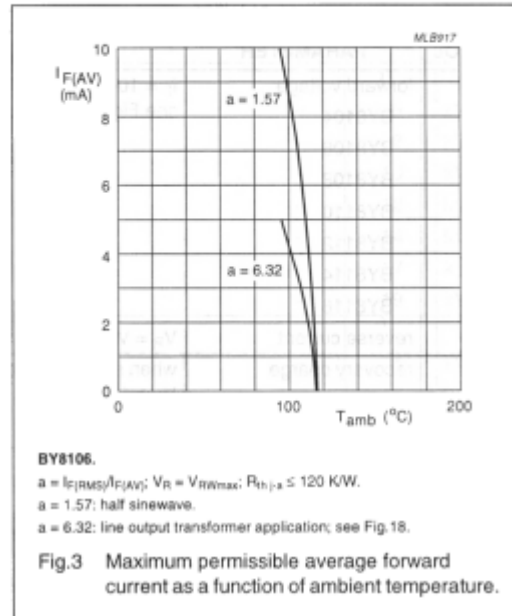
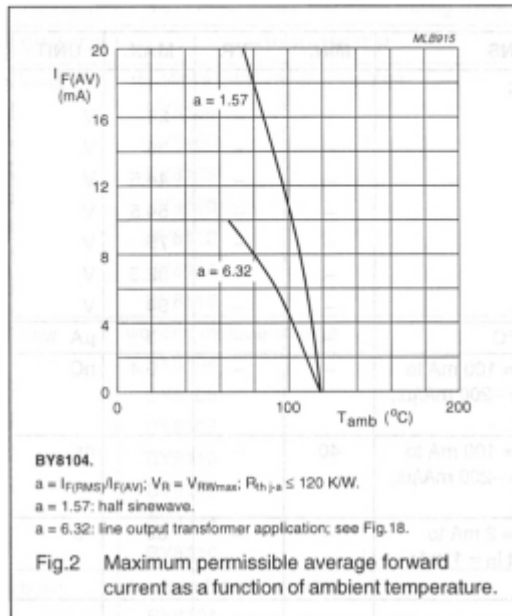

Very fast high-voltage soft-recovery controlled avalanche rectifiers

BY8100 series

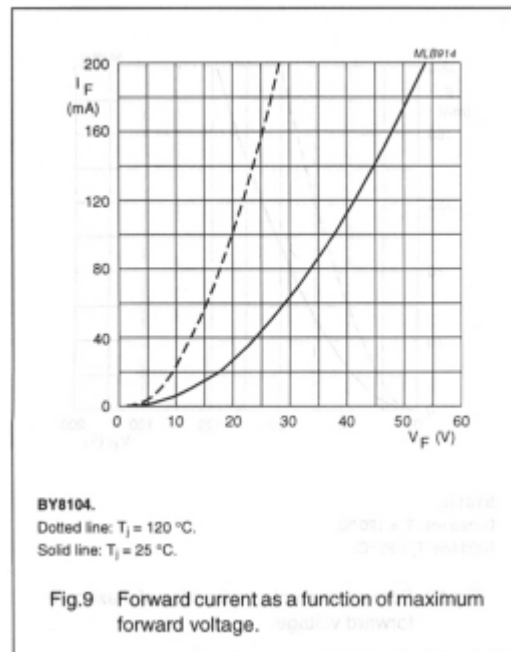
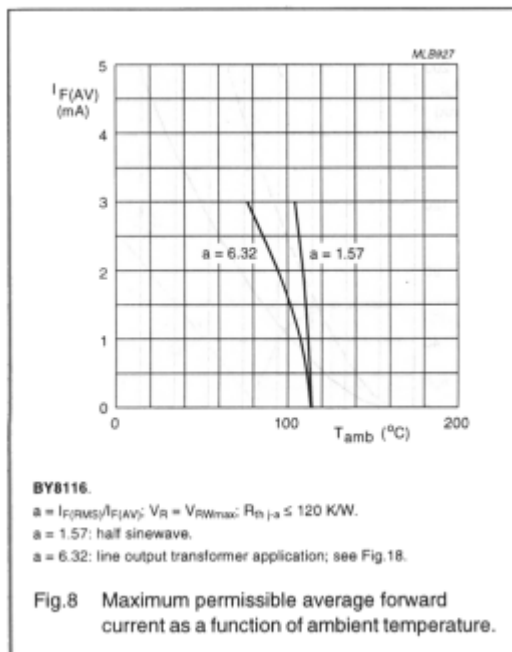
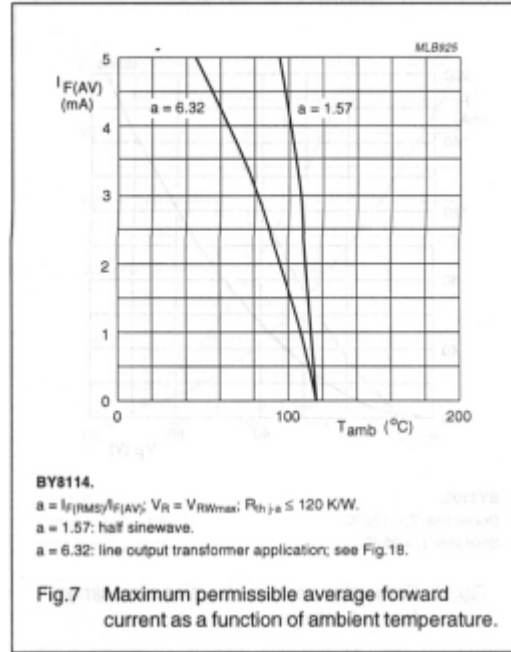
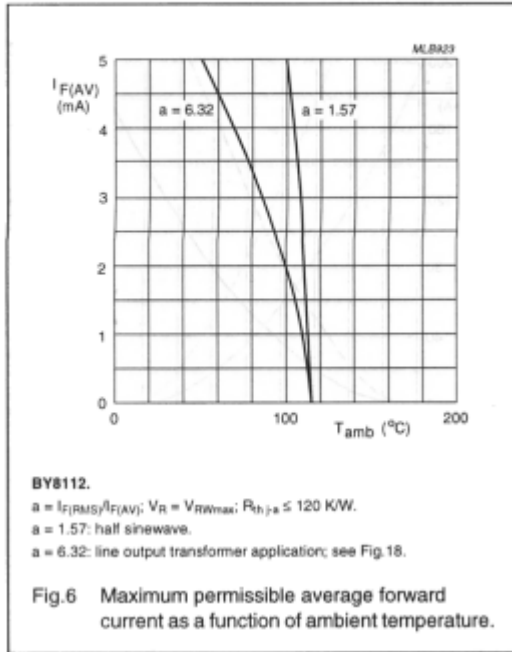

Very fast high-voltage soft-recovery
controlled avalanche rectifiers

BY8100 series

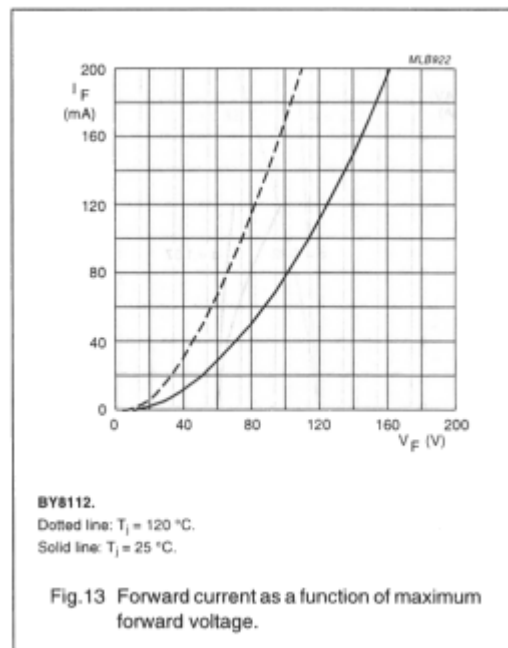
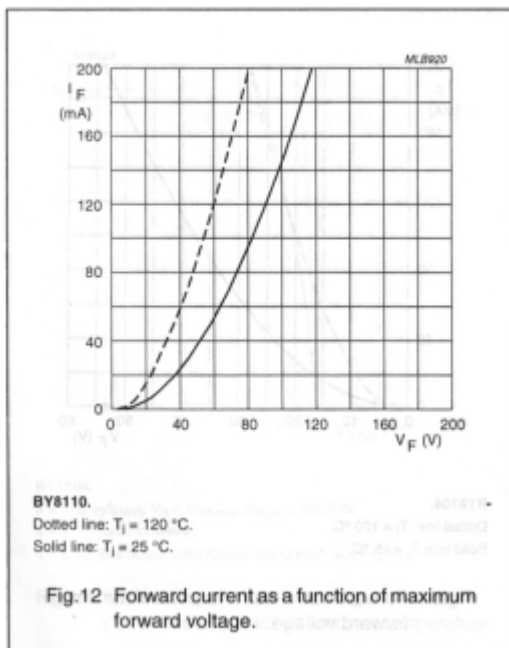
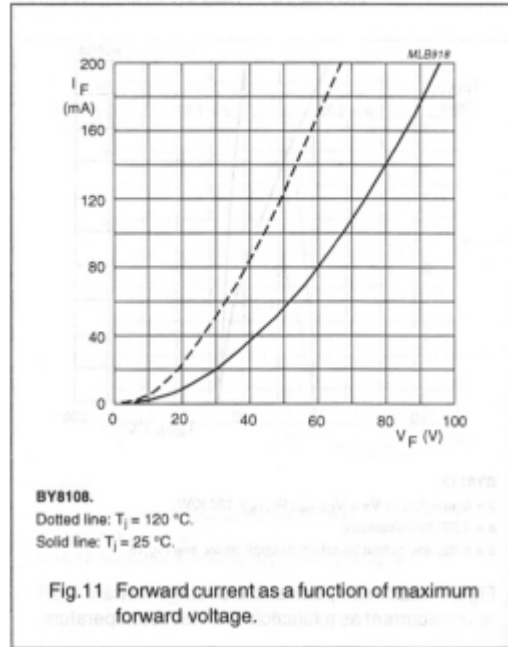
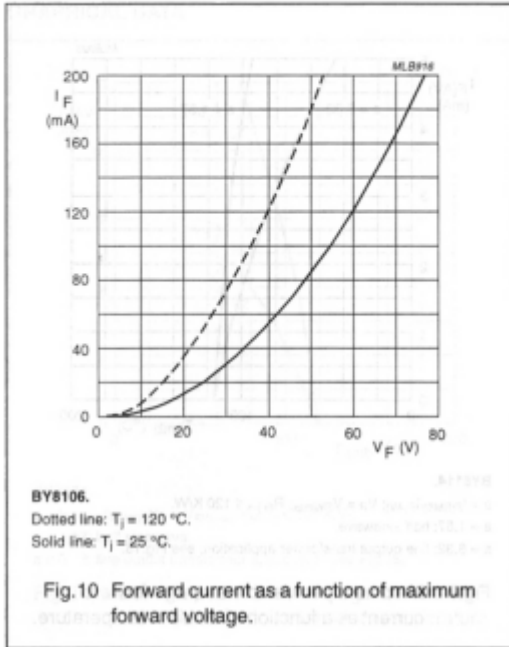

Very fast high-voltage soft-recovery controlled avalanche rectifiers

BY8100 series

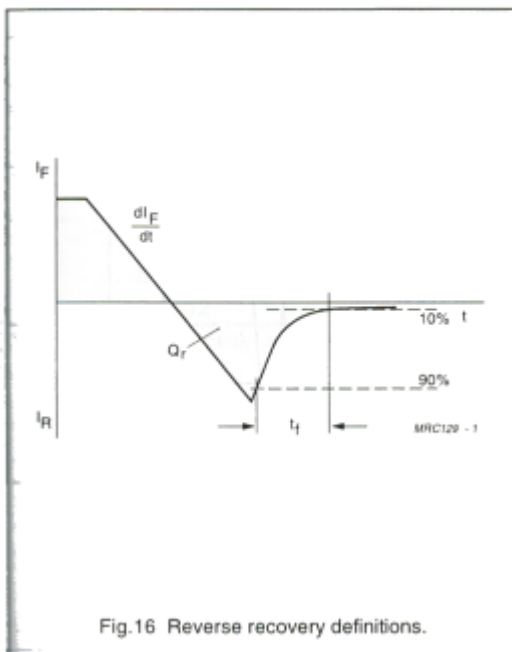
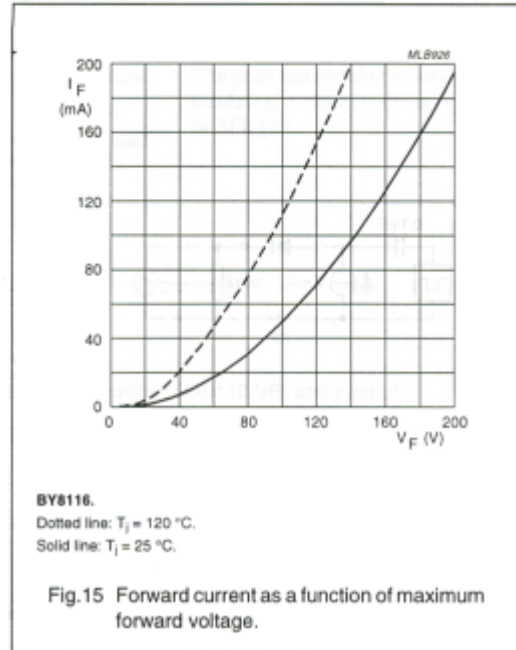
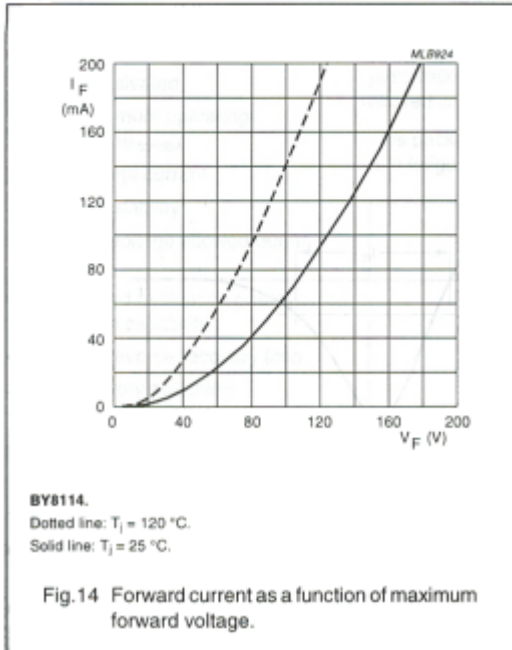

Very fast high-voltage soft-recovery controlled avalanche rectifiers

BY8100 series

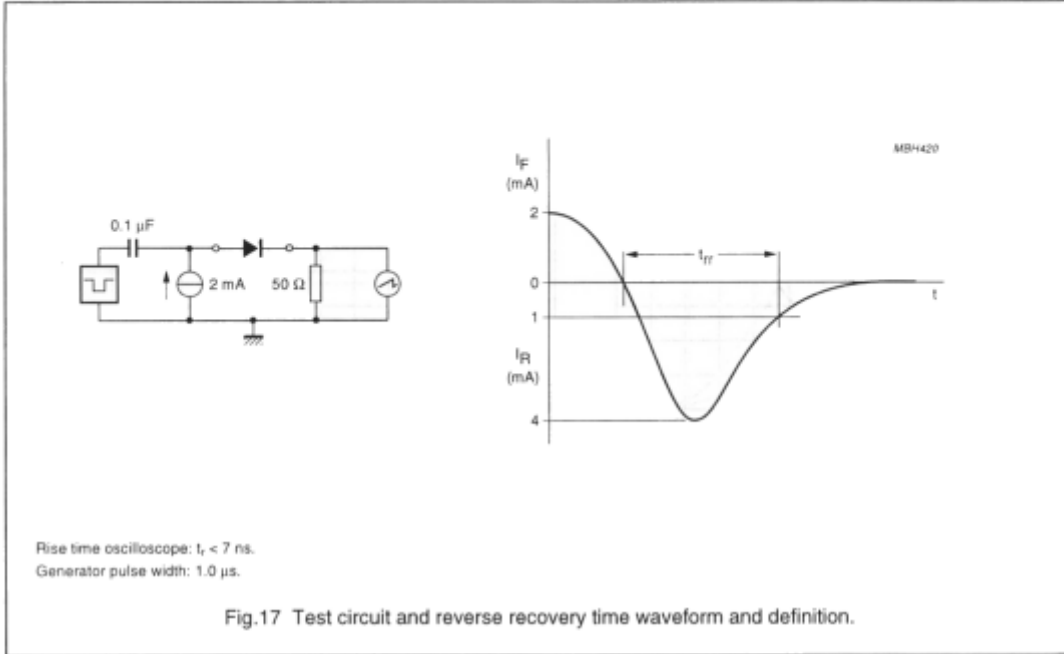

APPLICATION INFORMATION

